

USAGE

LED TAIL LIGHT USAGE INSTRUCTIONS

1. The Premier LED Tail Light is water-resistant. Although the light body is water-resistant (under normal weather conditions of rain, etc), never intentionally submerge it under water.
2. If the body or parts become dirty or have been exposed to any contaminants or dirt, gently clean with a soft towel using mild soap and water only. Lubricate and maintain the light body with silicon based grease on the O-rings. Never use harsh chemicals to clean the lighting system as damage to the housing and lens will occur.
3. Safely and properly dispose of the old batteries according to your location regulations.
4. Never place this lighting system within a child's reach.
5. For ultimate safety, the Premier LED Tail Light should be used in conjunction with reflectors, and possible additional front lighting deemed necessary.
6. Always wear an approved bicycle helmet when riding.
7. Riding a bicycle at night is dangerous and could result in injury or possible death.

INSTALLATION

BRACKET INSTALLATION

1. UNSCREW

Turn the screw counter clockwise to loosen

2. WRAP

Wrap bracket around the bicycle tube

3. TIGHTEN

Turn the screw clockwise to tighten

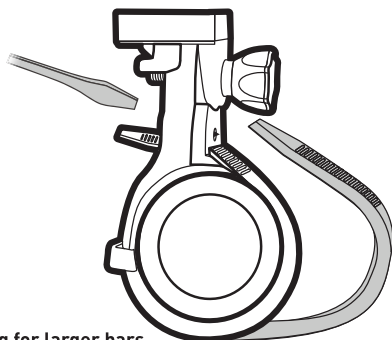

NOTE: Remove the inside bushing for larger bars

MOUNTING LOCATIONS

PREFERRED LOCATION

SECONDARY LOCATION

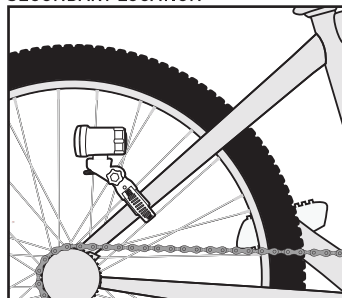
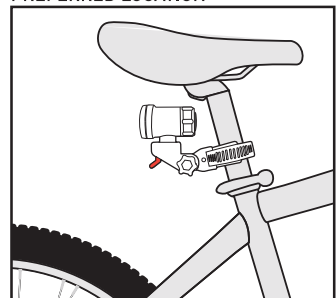

LIGHT MOUNTING & REMOVAL

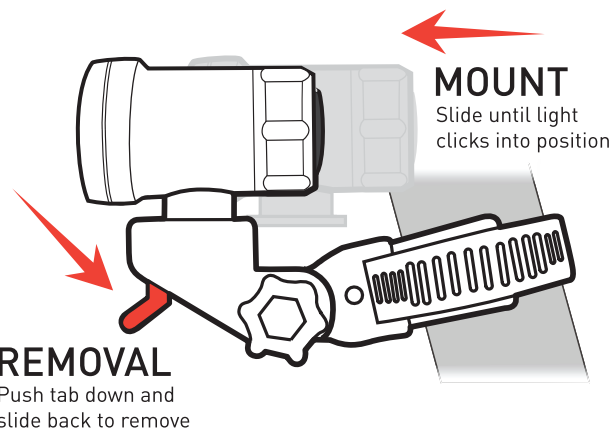

LIGHT ADJUSTMENTS

1. LOOSEN

Loosen screw to adjust the angle of the light

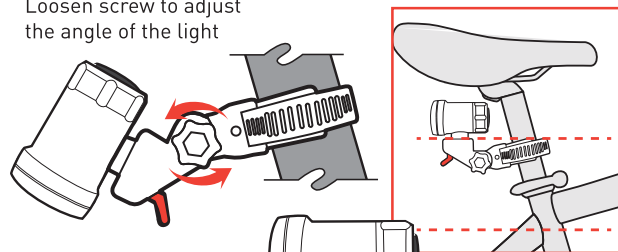

2. TIGHTEN

Level light parallel to the ground and tighten

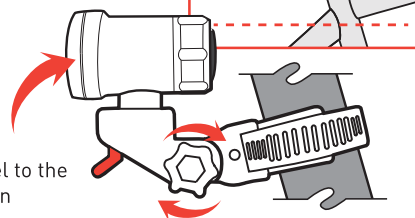

OPERATIONS

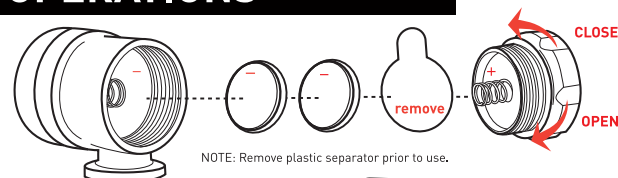

BATTERY 2x2032 (3V)

NOTE: Do not mix old and new batteries and do not mix alkaline, standard (carbon-zinc) or rechargeable (Ni-cad, Ni-mh, etc.) batteries.

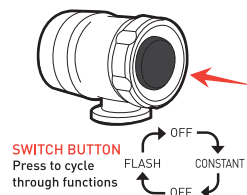

DELUXE LED BICYCLE LIGHT SET USER'S GUIDE

FOR ANY QUESTIONS OR CONCERNS,
PLEASE EMAIL CUSTOMERSERVICE@ALLENSPORTSUSA.COM

www.ALLENSPORTSUSA.com
800.722.5536

Distributed by R.A. Allen Sports USA Inc. 60 Thoreau St. #161 Concord, MA 01742, USA. The distinctive shapes, styles, packaging, configurations and overall appearances of all Allen Sports products are trademarks of Allen Sports USA.

USAGE

LED HEAD LIGHT USAGE INSTRUCTIONS

1. The Premier LED Head Light is water-resistant. Although the light body is water-resistant (under normal weather conditions of rain, etc), never intentionally submerge it under water.
2. If the body or parts become dirty or have been exposed to any contaminants or dirt, gently clean with a soft towel using mild soap and water only. Lubricate and maintain the light body with silicon based grease on the O-rings. Never use harsh chemicals to clean the lighting system as damage to the housing and lens will occur.
3. Safely and properly dispose of the old batteries according to your location regulations.
4. Never place this lighting system within a child's reach.
5. For ultimate safety, the Premier LED Head Light should be used in conjunction with a rear safety LED, reflectors, and possible additional front lighting deemed necessary.
6. Always wear an approved bicycle helmet when riding.
7. Riding a bicycle at night is dangerous and could result in injury or possible death.
8. In addition to its brightness, the beam is widely diffused. In case you need to use this light on public roads, be sure to adjust the angle downward so as not to blind oncoming traffic.

INSTALLATION

BRACKET INSTALLATION

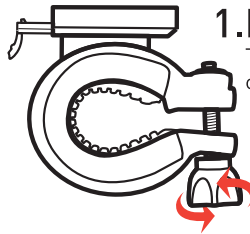

1. LOOSEN

Turn the screw counter clockwise to loosen

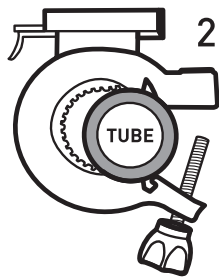

2. WRAP

Wrap bracket around the bicycle tube

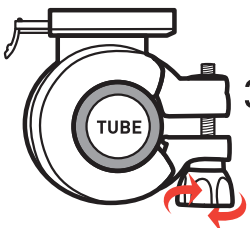

3. TIGHTEN

Turn the screw clockwise to tighten

NOTE: Remove the inside bushing for larger bars

LIGHT REMOVAL

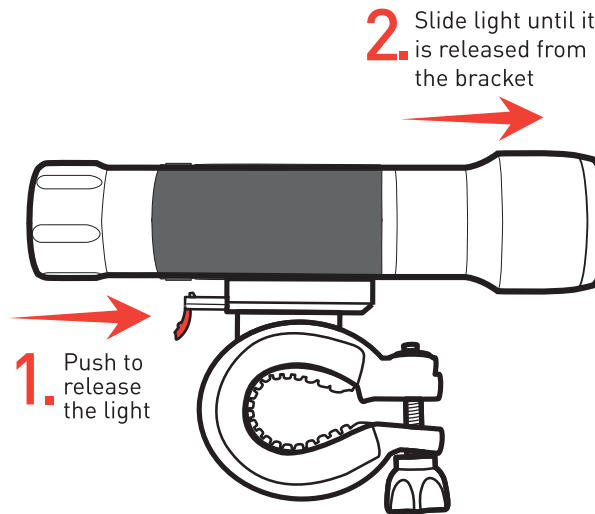

LIGHT MOUNTING

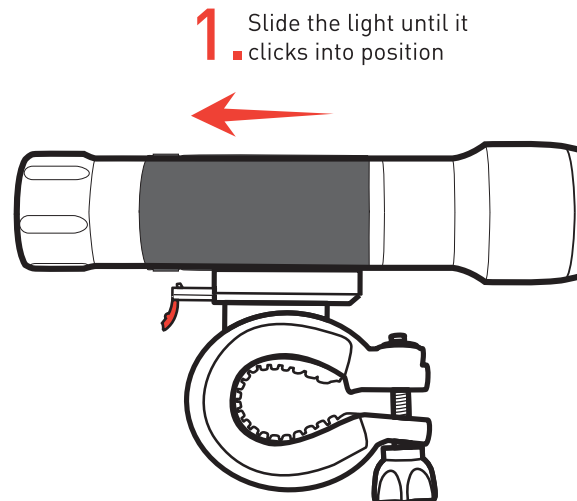

BATTERY REMOVAL



Battery 3 x AAA (1.5V - LR03)

Note:

Do not mix old and new batteries and do not mix alkaline, standard (carbon-zinc) or rechargeable (Ni-cad, Ni-mh, etc.) batteries

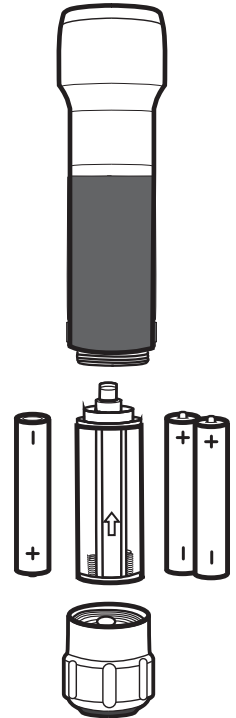

LIGHT OPERATION

SWITCH BUTTON

Press to cycle through functions

